

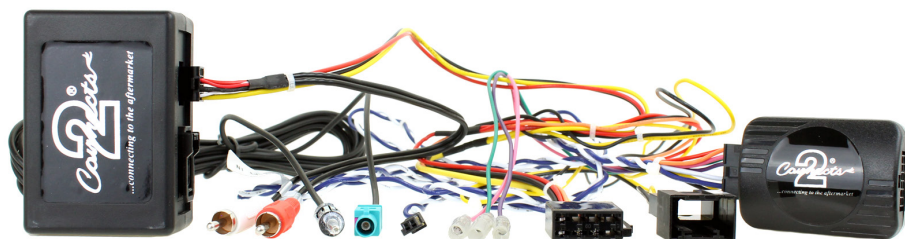

*...connecting to the aftermarket*

**CTSMC013.3**

**Mercedes Benz Steering Wheel Control Interface  
With Voice Assistant Control**



**INSTRUCTION MANUAL**

*[www.connects2.com](http://www.connects2.com)*

Designed and  
Engineered  
in the UK. 

## CTSMC013.3

Mercedes Benz Steering Wheel Control Interface with Voice Assistant Control for Mercedes Benz Vehicles with CAN-Bus.

### Product Contents

- Interface
- Harness
- Instruction

### Application

E-Class (W211) 2002 - 2009

For Fibre Amplified Vehicles

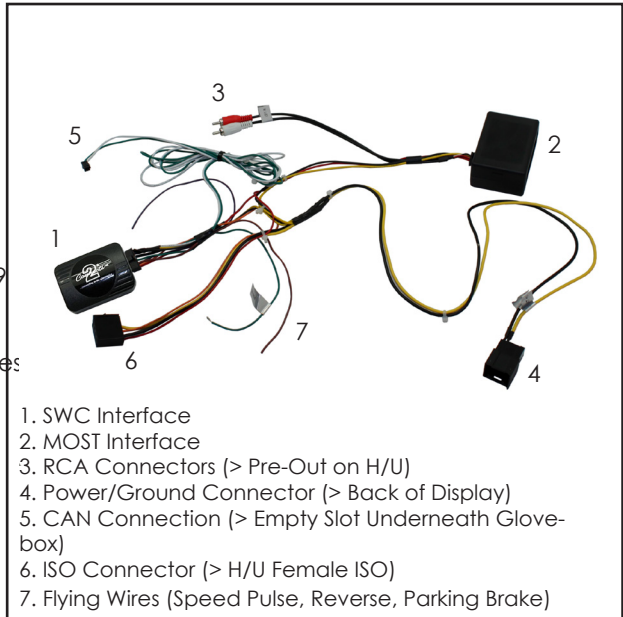

### Prior to installation

Read the manual prior to installation. Technical knowledge is necessary for installation. The place of installation must be free of moisture and away from heat sources. Please ensure you use the correct tools to avoid damage to the vehicle or product.

**Connects2 can not be held responsible for the installation of this product.**

### Technical Support

Connects2 want to provide a fast and suitable resolution should you encounter any technical issues. With this in mind, when contacting Connects2, try to provide as much Information as possible. This will speed up the process and help us to help you.

Please use our dedicated online technical support centre: [support.connects2.com](http://support.connects2.com)



Subscribe to our YouTube Channel for installation guides and tips... [www.youtube.com/connects2](http://www.youtube.com/connects2)

## FITTING GUIDE

---

1. Remove and disconnect the original head unit.
2. Connect the 12 way molex connector of the head unit patch lead (supplied separately) to the interface.

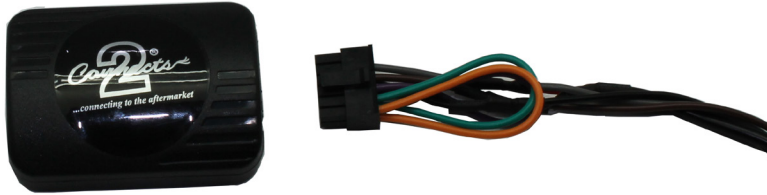

3. Connect the opposite end of head unit patch lead to the head unit steering wheel control input on the back of the aftermarket head unit. This may be a 3.5mm jack plug or a wire input depending upon the head unit brand being fitted. Please see the head unit installation manual for further information on where to connect.

**Important Note: This step must be completed before connecting power to the interface. Failure to do so may result in no steering wheel control function.**



4. Connect the 14 way molex connector to the interface.



## FITTING GUIDE

---

5. Connect the male power/speaker ISO harness to the female power/speaker ISO harness from the aftermarket head unit.

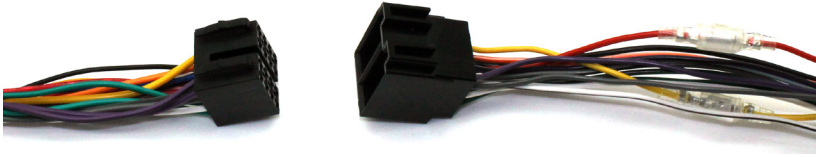

For aftermarket head units which do not have an ISO connector the interface uses the following wiring colours:

Wire Colour	Function
Yellow	Permanent 12V
Black	Ground
Red	12V Ignition
Orange	Illumination
Blue	Antenna Remote
Pink	Speed Pulse
Green	Park Brake
Purple/White	Reverse

Wire Colour	Function
Purple	Right Rear Speaker +
Purple/Black	Right Rear Speaker -
Green	Left Rear Speaker +
Green/Black	Left Rear Speaker -
Grey	Right Front Speaker +
Grey/Black	Right Front Speaker -
White	Left Front Speaker +
White/Black	Left Front Speaker -

6. Connect the Yellow/Black Fibre Amp retention connector to the power connector (previously removed from the back of the head unit)

7. Remove the kicker panel beneath the glove-box (pictured) and feed the Blue/White CAN wire behind the dashboard and out under the glovebox



Remove panel to gain access to CAN Hub

## FITTING GUIDE CONT.

---

8. Plug Blue/White connector into a vacant slot in the CAN Hub (pictured)

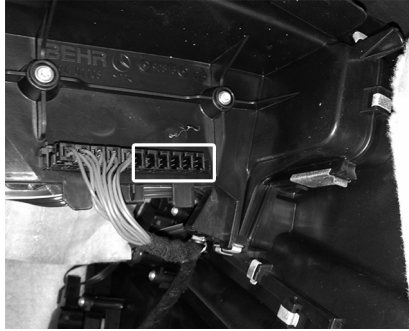

9. Connect the 8-Way connector to the MOST Interface

10. Connect the White/Red RCA connectors to the pre-out at the back of the head unit

11. Test head unit for correct operation and reinstall glove box panel and dashboard

## STEERING WHEEL CONTROL FUNCTIONS

---

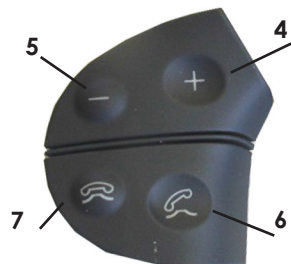
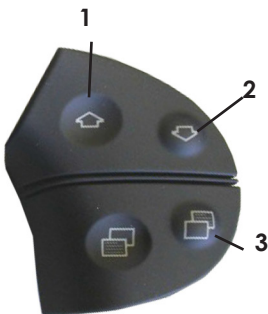

1. Track +  
2. Track -

3. Source  
4. Volume +

5. Volume -  
6. Short Press = Pick Up  
Long Press = Voice Assistant

7. Hang Up





