

SWEDISH • AUDIO • PASSION

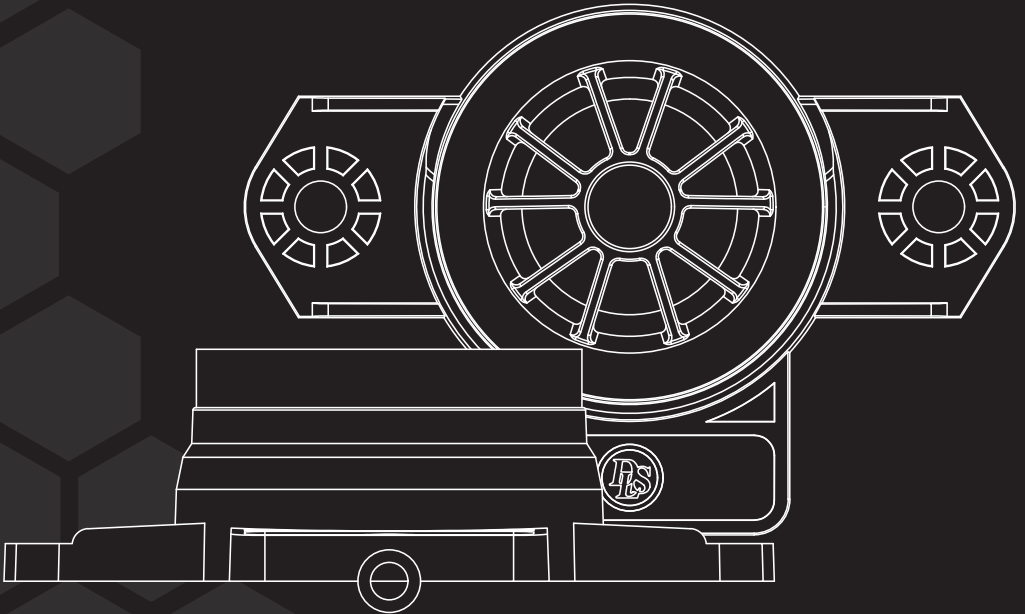

CRPP-VO2.14/18

User manual

VOLVO



CRUISE

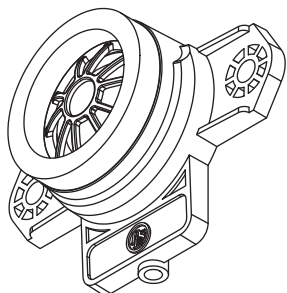

Welcome to DLS!

Thank you for buying a DLS Cruise CRPP-VO2.14/18. For us, it's all about the sound experience. We care deeply about sound and construction quality. In order for your experience to be as optimal as possible, it is important that you read this manual, preferably before you start your installation. Keep the manual in a safe and accessible place for future reference.

Your tweeters must be installed correctly in order to work as intended. Make sure you have all necessary tools nearby before starting and that you are completely confident in how to proceed. If you feel the slightest uncertainty; feel free to take the help of an experienced installer or a car audio dealer.

Warranty

This tweeter is covered by warranty, depending on the conditions in the country where it is sold. If the tweeter is returned for service, please include the original dated receipt with the product.

General

Some sound systems may vary in size of the installed tweeters. Make sure that your vehicle has the same size as this tweeter, before you start the assembly.

This is a generic mounting instruction. The approach is similar to all of the described car models. Some screws and clips may be placed differently depending on your car model.

DECLARATION OF CONFORMITY

DLS Cruise tweeters for vehicles are manufactured in accordance with the EU directive EEC 95/54 (72/245/ EEC) and are marked with the approval number. They are also marked in accordance with the WEEE-directive 2012/19/EC. The products are also produced in accordance with the EU RoHS directive 2015/863/EU.

DLS CRUISE

CRPP-VO2.14/18

Content

Welcome	1
Warranty	1
General	1
Declaration of conformity	1
Included parts	2
Pre installation	2
Mounting info	2
General door panel dismounting	3
Installation	4
Dismount door panel	4
Change tweeters	6
Crossover	7
Reassemble door panel	7
Cable adaptor	8
Running-in time	8
DLS support	8
Specifications	9
Impedance vs Frequency	9
Dimensions	10
Compatible car models	11
Product markings	12

DLS speakers are engineered by DLS Sweden,
a part of:

Winn Scandinavia AB

Elementvägen 15 - SE-702 27 Örebro - Sweden

Tel: +46 19 20 67 65 - E-mail: info@dls.se

www.dls.se

Designed & Sound tuned in Sweden.



Included parts

Included products:

2pcs Tweeters
2pcs Crossovers

Included in box:

4pcs Adhesive foams for wrapping
4pcs Terminal crimp connectors
2pcs Tweeter adaptor cable bar ends (marked with TW-A)
2pcs Tweeter adaptor cable (marked with TW-B)
1pc Pry tool
1pc Manual

Pre installation

Disconnect Battery

Before you start the process of replacing speakers, disconnect and secure the negative terminal from your battery/power source. This will prevent the risk of damaging yourself or the products.

Place the disconnected terminal in a secure and isolated location away from any possible connection belonging to the battery/power source system.

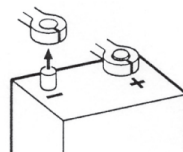

Mounting info

Some sound systems may vary in size of the door speaker. Make sure that your vehicle has the same speaker size as this speaker, before you start the assembly

Bolts size can vary between 7 & 8 mm
Torx size can vary between T20 & T25



General door panel dismantling

This is a generic mounting instruction. The approach is similar to all of the described car models. Some screws and clips may be placed differently and depending on your car model (see specific car models on the following page).

Remove the trim panel by using a PRY tool:



Remove the window control panel using PRY tool.
Unplug the harness:



T20/T25 screw is located under the panel.
Remove screw.



Remove the bolts using 7mm hex bit:



T20/T25 screw can be seen from under the arm rest, or there's a cover that needs to be removed.

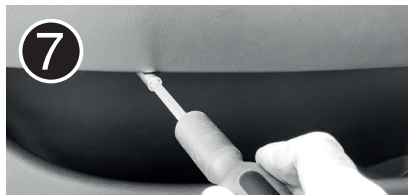

Finally. Move the door panel upwards to dismount.

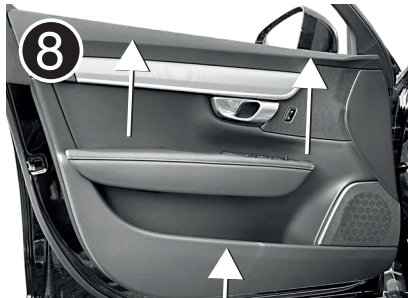



Installation

Dismount door panel

Dismount the door by removing the cover of the door panel.

Hint: Use plastic PRY tools to avoid marks on the panels or damaging the plastic clips.

XC90



1) Remove the cover behind the door handle. Use PRY tool. Behind the cover are two T20/T25 screw. Unscrew them. Move the door panel upwards.

Hint: Sometimes it's easier to remove the window control panel and unplug the harness, before lifting up the door panel.

S90/V90



S90/V90

Remove the trim panel by using a PRY tool. Start at 1) and move towards 2).

Behind the trim panel are two 7mm bolts located. Remove screw.

3) Remove the window control panel using PRY tool. Unplug the harness. T20/T25 screw is located under the panel. Remove screw.

4) T20/T25 screw can be seen from under the arm rest, or there can be a cover that needs to be removed.

Move the door panel upwards.

Remember: Use the PRY tools to avoid marks on the panels or damaging the plastic clips.



S60/V60



1) Remove the window control panel with PRY tool. Behind the control panel is one T25 screw located. Unscrew it. Unplug the harness. Start by removing the cover by the speakers. Use a PRY tool.

2) Start in the inside of the cover. Work your way towards the door handle.

3) Push the trim in the direction of the arrow. (There is a hook behind the trim)

Behind the trim is a 7mm bolt. Unscrew the bolt. Unplug the harness.

4) Under the arm rest is one T25 screw. Unscrew it. Move the door panel upwards.



XC60



- 1) Remove the window control panel with PRY tool. Behind the control panel is one T20/T25 screw located. Unscrew it. Unplug the harness.
- 2) Under the arm rest is one T20/T25 screw. Remove the cover. Unscrew it.
- 3) At the bottom of the panel is a 7 or 8mm bolt. Unscrew it.
Move the door panel upwards.

There are several electric and mechanical connectors on the backside of the door panel. Disconnect the cables to the door handle, speaker, window control and door light.



XC40



- 1) At the bottom of the panel are two 7 or 8mm bolts. Unscrew them.
- 2) Under the arm rest are two T20/T25 screw. Unscrew them.
- 3) Behind the door handle is a rubber cover. Remove cover and under it is a 7 or 8mm bolt. Unscrew the bolt.
Move the door panel upwards.

Hint: Sometimes it's easier to remove the window control panel and unplug the harness, before lifting up the door panel.



Change tweeters

Remove the tweeter by unscrewing the T20 Torx. Unplug the speaker harnesses.

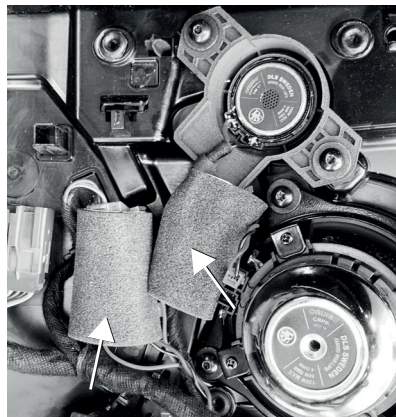
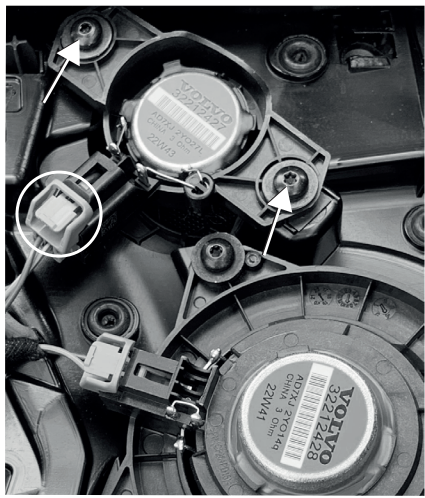

Make sure to use adhesive foam pads to wrap the crossover to avoid rattle and secure the crossover to the door panel.

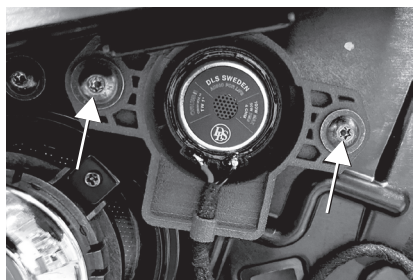

Plug in the new tweeter and the crossover, the connection cable can be used if needed. Use the OEM screws to fix the new DLS tweeter.



Make sure that the new DLS tweeter is properly fixed and don't touch the surrounding plastic.

HINT: DLS recommends adding sound deadening material on the door panel before the assembling.



Crossover

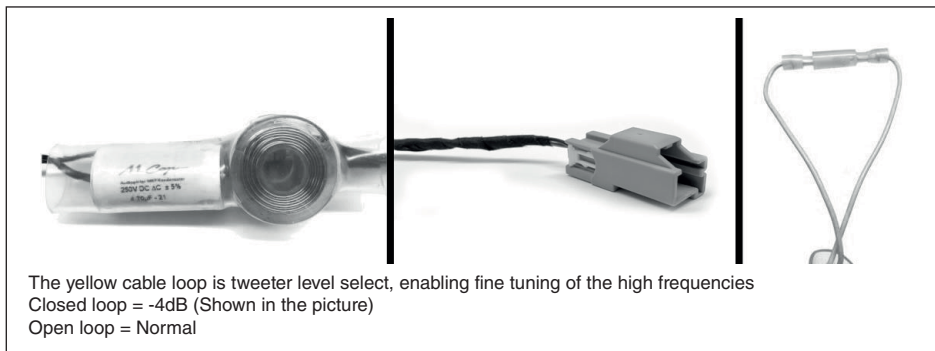

Reassembly door



Connect all plugs to the door cover, reconnect the unlocking device, place the door cover from the top, by the window seal and push it gently down. Make sure the clips are in place and can engage. Give the door panel a push by the hand to attach to the clips. Mount and fasten all screws to the correct places. Make sure that no screws or clips are left over.

Reconnect the battery/power source terminal.
Now it's time to play some good music and enjoy!



Cable adaptor TW-B



Note!

Adaptor cable marked with TW-B shall be used when replacing Bowers & Wilkins or Harman Kardon tweeter. This adaptor reverse the polarity of the signal to the tweeter.

Running-in time

Allow the speaker to play for at least 15-20 hours in order to perform at its possibly best. This run-in can be made with tone sweep or with just music.

Start at a moderate volume and increase the volume step by step during the running in period. After the 15-20 hour run in session the performance and characteristics will be in the correct condition.



DLS Support

For technical assistance, ask your car audio dealer where the product was sold or the distributor in your country. You can always contact the DLS Help desk in Sweden at e-mail: info@dls.se. Information can also be found on our WEB- site www.dls.se. We follow a policy of continuous advancement in development. For this reason, all or part of the specifications and designs may be changed without prior notice.



Specifications

Art. no Tweeter	CD-CRPP-VO2.14 1" / 25mm silk dome tweeter with accessories	Art. no Tweeter	CD-CRPP-VO2.18 1" / 25mm silk dome tweeter with accessories
RMS Power	50W	RMS Power	50W
MAX Power	100W	MAX Power	100W
Impedance	4 Ohm	Impedance	8 Ohm
Sensitivity	94dB 1W/1M	Sensitivity	94dB 1W/1M
Freq. range	2000 - 25000Hz	Freq. range	2000 - 25000Hz
Crossover	High pass / 4800Hz / 12dB	Crossover	High pass / 4800Hz / 12dB
Technical specifications		Technical specifications	
Voice Coil Material	CCAW voice coil/ Aluminum former	Voice Coil Material	CCAW voice coil/ Aluminum former
Frame	Glass Fibre Reinforced ABS	Frame	Glass Fibre Reinforced ABS
Magnet	Neodymium / Copper shorting ring / Ventilated back plate	Magnet	Neodymium / Copper shorting ring / Ventilated back plate
Cone	Natural silk dome with internal damping pad	Cone	Natural silk dome with internal damping pad
Crossover	Mundorf® caps, Mox resistors, Air coil, hard wire	Crossover	Mundorf® caps, Mox resistors, Ait coil, hard wire
Attenuation L-Pad	0/-4dB level	Attenuation L-Pad	0/-4dB level
Electro-Acoustic Parameters		Electro-Acoustic Parameters	
Re	3.4 Ohm	Re	7.2 Ohm
Fs	1950Hz	Fs	1950Hz
Spl	94dB 1W/1M	Spl	94dB 1W/1M

Impedance VS Frequency

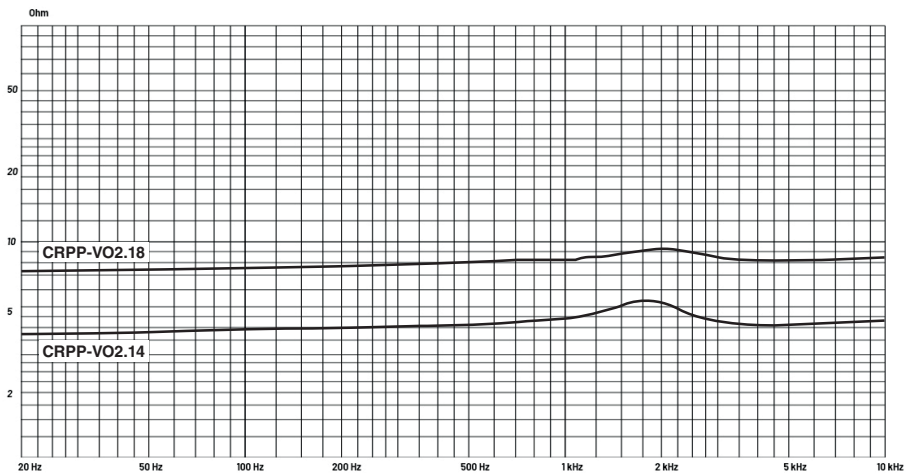



Dimensions

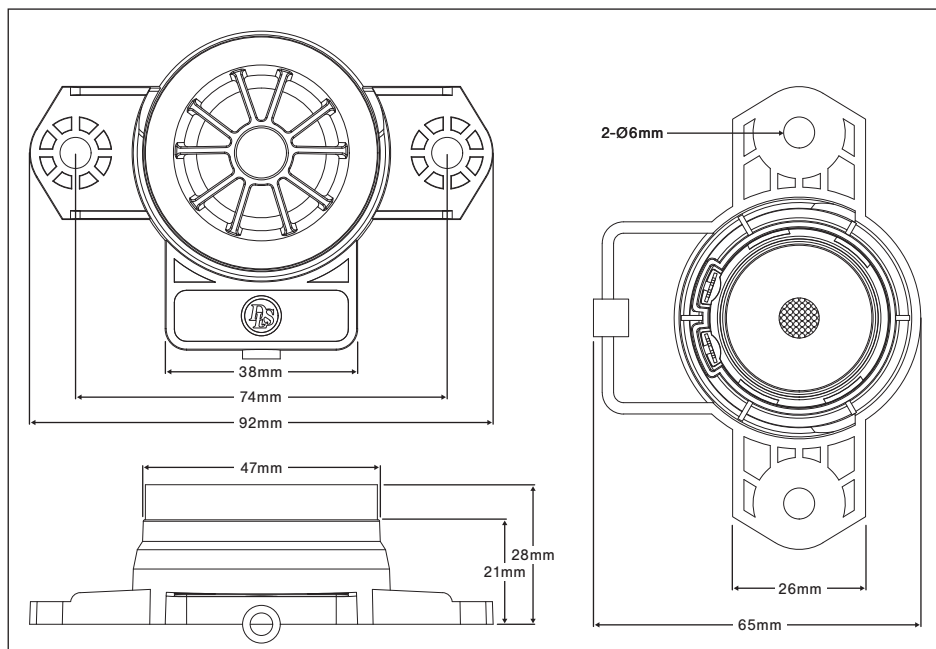



Compatible car models

The DLS Cruise CRPP-VO2.14 & CRPP VO2.18 tweeters are developed to be installed in the front door of Volvo car models.

DLS Cruise CRPP-VO2.14 compatible car models

Car	Model	Year	Front speaker	Rear speaker
Volvo	S60/V60	2018-Present	CRPP-VO2.14*	
Volvo	S90/V90	2016-Present	CRPP-VO2.14*	
Volvo	XC40	2017-Present	CRPP-VO2.14*	
Volvo	XC60	2017-Present	CRPP-VO2.14*	
Volvo	XC90	2014-Present	CRPP-VO2.14*	

*Disclaimer

Only compatible with Harman/Kardon and B&W sound system.

DLS Cruise CRPP-VO2.18 compatible car models

Car	Model	Year	Front speaker	Rear speaker
Volvo	S60/V60	2018-Present	CRPP-VO2.18**	
Volvo	S90/V90	2016-Present	CRPP-VO2.18**	
Volvo	XC40	2017-Present	CRPP-VO2.18**	
Volvo	XC60	2017-Present	CRPP-VO2.18**	
Volvo	XC90	2014-Present	CRPP-VO2.18**	

**Disclaimer

Only compatible with Performance and High Performance sound system.



Product markings



The crossed-out wheellie bin symbol means that the product, literature and packaging included must be taken to separate collection at the end of their working life. Do not dispose of these products as unsorted municipal waste: take them for recycling. For info on your nearest recycling point, check with your local waste authority.



This product has been granted with the CE certification mark to show that the product follows the health, safety, and environmental protection standards for products sold within the European Economic Area (EEA).



DLS products complies with the relevant provisions of the RoHS Directive for the European Union. In common with all Electrical and Electronic Equipment (EEE) the product should not be disposed of as household waste. Alternative arrangements may apply in other jurisdictions.



DLS is a global partner of the European Mobile Media Association, an organisation that focus on promoting the custom made mobile media installations to consumers.

We follow a policy of continuous advancement in development. For this reason all or part of specifications & designs may be changed without prior notice. We reserve for possible typos, factual or numeric errors that may have been printed on any products, package designs, user manuals and/or other included accessories.



CRUISE **E**