

GAS
AUDIO POWER

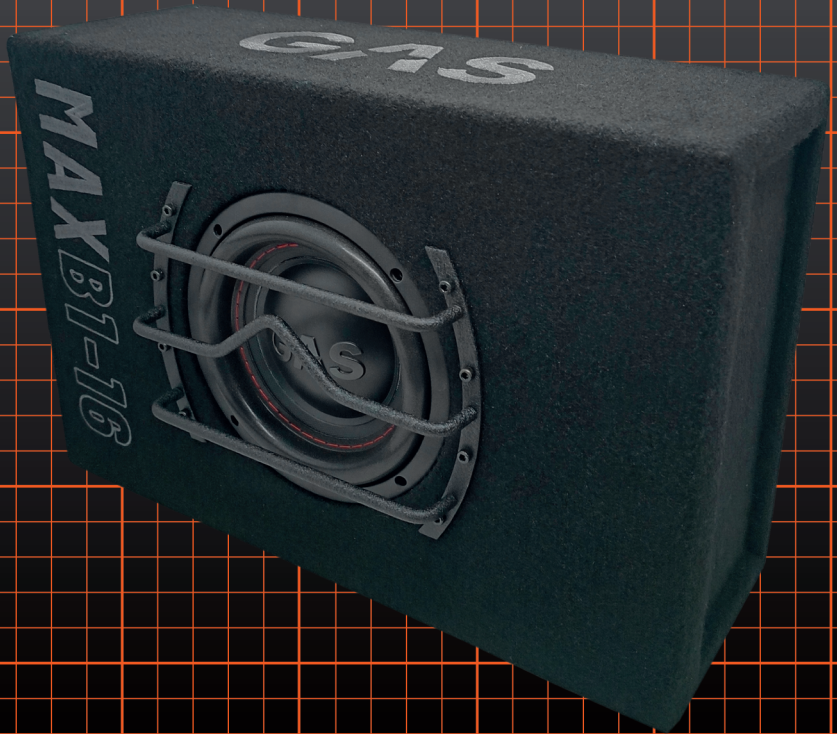

MAX B1

B1-16 / B1-18

HARDCORE CAR AUDIO

MAX USER MANUAL

WE PLAY LOUD!!

We know what you want. You want it LOUD, and that is exactly what we do, what we live for. Vibrations, gut-punches and straight up loud music - that's what makes us tick. We won't dress up in fancy words or claim to be something we're not. We are the NO BULLSH!T car audio brand!









Every single product with the GAS logo on it is born out of passion, the same that has driven us for two generations and that will keep us rolling up to your neighbourhood, winning and pushing the limits for many generations to come!

It's up to you to choose your own level of loud, and if you don't like what we do that's OK. You are welcome back when you've had your first true GAS experience. We don't exclude, we don't judge and we do not make up any excuses for who we are.

We are GAS and we are proud to be LOUD!

GAS

TABLE OF CONTENT

 SAFETY.....	3
 UNPACKING.....	4
 DIMENSIONS.....	4
 SPECIFICATIONS.....	5
MAX B1-16.....	5
MAX B1-18.....	5
 FEATURES.....	6
All you need and more.....	6
Precision car audio.....	6
Maximum bass.....	6
No compromise.....	6
 HOW TO.....	7
Install pre-loaded enclosure.....	7
 TROUBLESHOOTING.....	9
No power/sound.....	9
Distortion.....	9
 WARRANTY & DISPOSAL.....	10
 THE GAS WORLD.....	11



SAFETY

PLAY LOUD & SAFE. Read through this information, follow the instructions and save the manual for future usage and reference.

Make sure to pay attention to the instructions when you see this symbol: 

Do not expose your new loaded enclosure to excessive damp or moisture. If the enclosure/subwoofer is exposed it might result in electric failure, shock or damage to the product. Servicing is required when the product has been damaged in any way and/or doesn't operate normally. Refer all servicing to qualified service personnel only.

Keep the cables inside the vehicle separate from sharp edges or components that may be affected or take damage. Follow the recommended cable sizes and always use high quality cables and accessories. Even if you're eager to put the enclosure to use – take no shortcuts when installing the cables, make sure that all connectors are protected and secured.

Do not drill any holes without checking what lies beneath, and don't cut anything without making sure that no important components risk being damaged.

To avoid potential injury from enclosure movements, the pre-loaded enclosure must be securely fastened in the vehicle on a suitable location.

There is a first time for everything, if you need help – ask a friend or contact your local GAS AUDIO POWER dealer/installer.

We want you to experience your product's MAD sound, but we don't want you to injure yourself or others. Use common sense, respect high pressure levels and volume, and follow your local laws and regulations.



UNPACKING

Unboxing your new MAX product is an experience, make sure that the enclosure and all the accessories are included in the packaging:

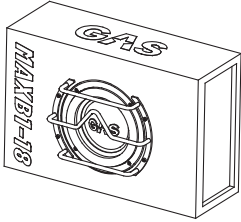

Loaded enclosure
(1 pc)



Manual
(1 pc)

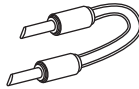

Jump cables
(2 pcs)



Feet
(4 pcs)



Screws
(4 pcs)

DIMENSIONS

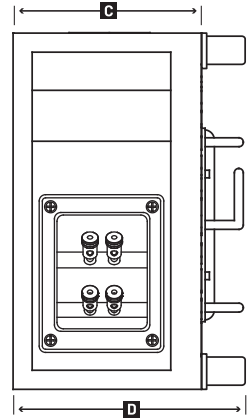
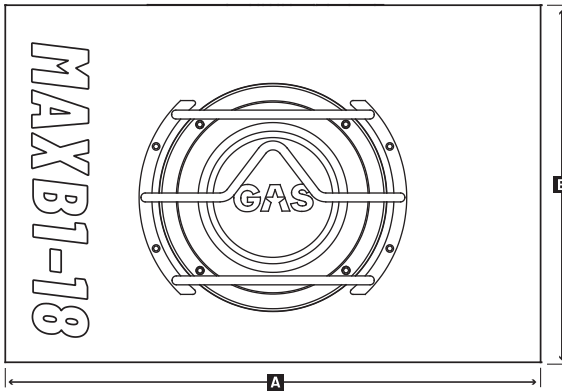

	A	B	C	D	
B1-16	420	280	148	188	mm
B1-18	480	330	168	208	mm

SPECIFICATIONS

Below you'll find the specifications that has been checked and tested in our workshop. The specifications aren't directly connected with the sound pressure in the vehicle, and shouldn't be used as the sole indicator for comparison with other enclosures. The MAX B1 enclosures are loaded with custom made subwoofers (see product specifications below).

MAX B1-16

Component	Pre-loaded Enclosure
Size	1x6.5" (165mm)
Nominal Impedance	2+2 Ohm
Power RMS	400W
Power MAX	800W
Volume	10.3 L
Weight	9.1 KG

MAX B1-16SW

Component	Subwoofer
Size	6.5" (165mm)
Nominal Impedance	2+2 Ohm
Power RMS	400W
Power MAX	800W
Freq. response	30-200Hz
Voice coil	Dual 2" PCW
Voice coil former	Aluminum
Cone	Non-Pressed Paper
Dustcap	3D IMPP
Basket	HD steel
Magnet	HQ Ferrite 2x30oz
Suspension	High roll foam w. stitch
Tinsel	Dual silver coated leads

MAX B1-18

Component	Pre-loaded Enclosure
Size	1x8" (200mm)
Nominal Impedance	2+2 Ohm
Power RMS	500W
Power MAX	1000W
Volume	17 L
Weight	11.3 KG

MAX B1-18SW

Component	Subwoofer
Size	8" (200mm)
Nominal Impedance	2+2 Ohm
Power RMS	500W
Power MAX	1000W
Freq. response	25-200Hz
Voice coil	Dual 2.5" PCW
Voice coil former	Aluminum
Cone	Non-Pressed Paper
Dustcap	3D IMPP
Basket	HD steel
Magnet	HQ Ferrite 2x56oz
Suspension	High roll foam w. stitch
Tinsel	Dual silver coated leads

FEATURES

ALL YOU NEED AND MORE

Are you ready to unleash the full power of your car's audio system? This is the GAS MAX B1-16/18, a custom enclosure fitted with a custom-made subwoofer based on the awesome MAX S1 series subwoofer. Designed for the hardcore bass heads out there, this is an enclosure that perfectly balances awesome power, weight, and musicality.

PRECISION CAR AUDIO

You know as well as we do that it takes more than a good subwoofer to get an awesome sound system, you need a great enclosure too. The MAX B1 enclosure has an optimized high output airflow slot port design that makes sure you get a more immersive listening experience with its enhanced extension and response. We have also included custom feet with the MAX B1 series enclosure, which lets you point the subwoofer downwards. This feature is perfect for those that want to squeeze every possible dB out of the enclosure!

MAXIMUM BASS

The enclosure is loaded with a custom-made subwoofer that was inspired by the MAX S1 subwoofer series. This woofer will show everyone that your audio dedication is real. With a rigid and durable cone made by non-pressed paper with Mica minerals, dual stitching (on the B1-18) and an impressive high roll foam suspension, you'll experience awesome cone movement and musicality like never before. The subwoofer has dual stacked HQ ferrite magnets, excellent cooling, a Nomex spider and an HD steel basket to make sure that your sound system will be the last thing standing.

NO COMPROMISE

There is no shortcut to get an awesome sound system. The MAX B1 series is made to push your car audio system to its limit. Its strong and durable enclosure will resist all the heavy vibrations and resonances it might face, and the stylish pre-mounted A-star grille will make sure the subwoofer is secure. The black edition dual push terminals and the included jump cables offer you a smooth and high-performing installation with easy impedance optimization. Show everyone that you've reached the next level, the MAX level, of car audio.



HOW TO

INSTALL PRE-LOADED ENCLOSURE

Before installing your brand new pre-loaded enclosure, make sure that you have everything you need. Have the right tools ready, and make sure that you have the necessary knowledge/skill to perform the installation properly. Preparation and knowledge is crucial!

The pre-loaded subwoofers in the MAX B1-16/B1-18 enclosures use double 2 Ohm voice coils. Since the enclosure is pre-loaded with a custom made MAX subwoofer, the installation is very simple. Just connect it with your amplifier and get ready for an awesome bass experience!

The MAX B1 enclosures have 2+2 Ohm impedance as its standard configuration, but it can be adjusted to 1 or 4 Ohm. It is important to know the limits of your amplifier to optimize its performance. You can vary the impedance by altering the wiring configurations by using the included jump jables. Choose the wiring diagram below that corresponds to the impedance stability of your amplifier.

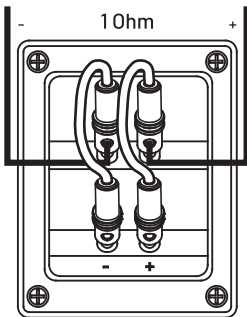

**parallel connection
(with jumpers)**

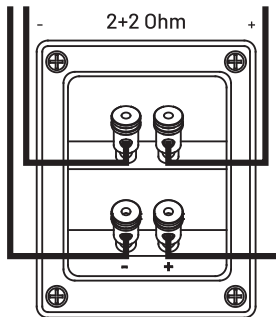

**singular connection
(no jumpers)**

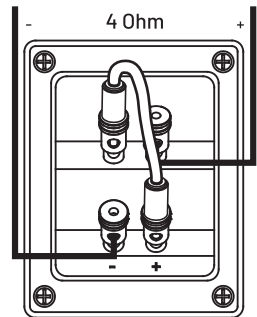

**serial connection
(with jumper)**

HOW TO

INSTALL PRE-LOADED ENCLOSURE



In the MAX B1 enclosure's packaging we have included special designed feet. By mounting the feet on the enclosure you can aim the subwoofer downwards or in any other direction you prefer.

Locate the included feet and included screws in the enclosure's packaging. Place the feet in the front corners of the enclosure. Place the screws through the hole on the feet and screw them tightly to lock the feet into place on the enclosure (see illustration below). If you want to, you can pre-drill holes in the enclosure for the screws with a 3mm bit.

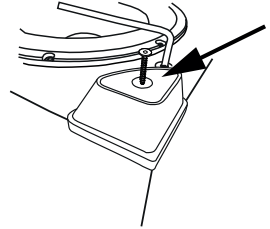
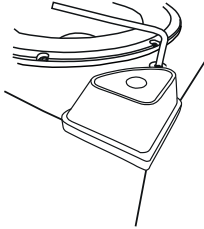
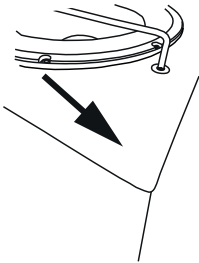

To make sure that the enclosure doesn't move around while you're driving, we recommend fastening the enclosure in the vehicle. One alternative is to use mounting brackets and screws to securely fasten it in position.

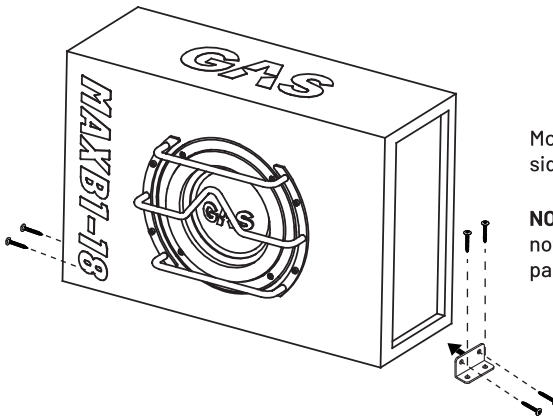

Mount one bracket on each side of the enclosure.

NOTE! These accessories are not included in the enclosure's packaging.

TROUBLESHOOTING

NO POWER/SOUND

Check the enclosure/subwoofer to make sure it isn't damaged. If your pre-loaded enclosure doesn't get any power, the most common issue is either in the wiring or in the amplifier. Use a multimeter to measure the amplifier's voltage on the +12V terminal and the remote signal terminal. Make sure that you have a negative ground connection. Check the built-in fuse (if there is one) on the amplifier. If there's no power coming through - control the fuse on the power cable. If the fuse is intact you should check all of the wiring to ensure cable integrity.

DISTORTION

Start by looking over the enclosure/subwoofer so there's no damage or connection issue with the wiring. Check the speaker cables to make sure that the polarity isn't reversed on one channel. Check the settings on the amplifier, make sure that the gain/level function is set according to the amplifier's instructions. If your amplifier has a boost function, lower its effect or turn it off.

When all of the above has been tested/looked over, and all is as it should be but the pre-loaded enclosure still has no power/sound or other problems, consult your local GAS AUDIO POWER dealer/installer

WARRANTY & DISPOSAL

This product is covered by warranty, depending on the conditions in the country where it's sold. If the pre-loaded enclosure is returned for service, please include the original dated receipt (or a copy) with the product. Make sure that the enclosure is packaged properly and secured, preferably in its original packaging.



The crossed-out wheeie bin symbol means that the product, literature and packaging included must be taken to separate collection at the end of their working life. Don't dispose of these products as unsorted municipal waste: take them for recycling. For info on your nearest recycling point, check with your local waste authority.



This product has been granted with the CE certification mark to show that the product follows the health, safety, and environmental protection standards for products sold within the European Economic Area (EEA).



GAS Audio Power products comply with the relevant provisions of the RoHS Directive for the European Union. In common with all Electrical and Electronic Equipment (EEE) the product shouldn't be disposed of as household waste. Alternative arrangements may apply in other jurisdictions.



GAS Audio Power is a global partner of the European Mobile Media Association, an organization that focus on promoting the custom made mobile media installations to consumers.

THE GAS WORLD

You've entered the world of GAS. We aim to please, and we've made sure to have products made for you. No matter what stage of the LOUD-addiction you might find yourself in, there is a GAS product to fill your need.

MAD

Just starting out? The MAD series is made to play LOUD and to be the express lane to a no bullsh!t sound system that will make sure everyone can hear you coming!

MAX

The MAX series holds products made to deserve the center stage. Powerful, heavy duty and designed to be noticed. We made NO COMPROMISES because we know that you wouldn't accept it.

CMP

The CMP series has been developed for the crucial seconds when the dB-counter starts to tick. All CMP products have hand-picked, high quality, COMPETITION GRADE components and they are specially designed to withstand an awesome amount of power.



THANKS FOR JOINING GAS AUDIO POWER!



GAS
AUDIO POWER

GAS AUDIO POWER and SHAKY are registered trademarks by Winn Scandinavia AB and is protected by relevant laws and jurisdictions such as Copyright and Trademark laws.

Winn Scandinavia AB | Elementvägen 15, 70227 Örebro, Sweden | www.winnscandinavia.com

Winn Scandinavia AB reserves for possible typos, factual or numeric errors that may have been printed on any products, package designs, user manuals and/or other included accessories.





GAS
AUDIO POWER