



How to install and operate the
DLS amplifier models

P10, P20 P40, M40, P44

Contents

Features.....	2
Installation.....	2
Routing Wires.....	2
Tools and materials needed.....	3
Wiring & crossovers:	
Power and remote wiring.....	3-4
Low & High level input wiring	4
Input level control, BASS EQ.....	5
Features on each model	5
P10 speaker wiring:	
One or two subwoofers.....	6
P20 speaker wiring:	
Front speakers.....	7
Subwoofer.....	7
P40 / M40 / P44 speaker wiring:	
Four speakers.....	8
Two speakers and bridged subwoofer.....	8
Two subwoofers	9
Testing.....	10
Troubleshooting.....	10
Professional tips.....	11
Specifications.....	12

Welcome!

This owners manual is written in easy english and uses a lot of drawings to simply the installation and use of the above amplifiers.

Your DLS amplifiers must be installed correctly in order to work well. This manual will show you how to install the amplifier like a pro. Please read the entire manual before beginning the installation. Install the amplifier yourself if you feel confident with our instructions and if you have the proper tools. However if you feel unsure, turn over the installation job to someone better suited to it.

Warranty Service

This amplifier is covered by warranty, depending on the conditions in the country where it is sold. If the amplifier is returned for service, please include the original dated receipt with the product.

Technical Assistance

For technical assistance ask the shop where the product was sold or the distributor in your very country. Information can also be found on our WEB-site www.xprogram.com

We follow a policy of continuous advancement in development. For this reason all or part of specifications & designs may be changed without prior notice.

DECLARATION OF CONFORMITY

DLS amplifiers for vehicles are manufactured in accordance with the EU directive EEC 95/54 (72/245/EEC) and are marked with the approval number. They are also marked in accordance with the WEEE-directive 2012/19/EU.

The products are also produced in accordance with the EU RoHS directive 2011/65/EU.



This product must be returned to the separate collection system for electronic products. Do not dispose this product together with general household waste.

DLS amplifiers are designed and engineered by:

DLS Svenska AB
P.O. Box 13029 - SE-40251 Göteborg - Sweden
Tel: +46 31 840060 - Fax: +46 31 844021
E-mail: info@dls.se
www.dls.se



The models include the following features:

- Analogue class AB technique
- High efficiency
- Low profile design
- RCA line inputs
- High level input with auto start
- Powerful cable terminals
- Built-in active crossovers
- Remote sub level control

Installation

Before you begin installation

Before you begin you need to read the manual, to have some tools, cables and other material available. There is one such list of material on the following page.

Amplifier location

Important
Allow air circulation around the amplifier. The P10, P40/44 include an electric fan in the bottom plate. There must be free space under the amplifier for a good air circulation.

The DLS series of amplifiers have a compact design that allows great flexibility in mounting. You can mount it under a seat or in the trunk. When you select a location, do remember that the amplifier generates a lot of heat. Choose a location where air can circulate freely around the amplifier. Do not cover the amplifier with carpets or hide behind trim panels. Do not mount the amplifier in an inverted or upside down position.

Check all locations and placements carefully before making any cuts, drilling any holes or making any connections.

IMPORTANT!
Use the metal screws coming with the amplifier when you do the install. Do not use oversized screws, you may destroy the plastic ears by doing so.

Disconnect Battery

Before starting the installation, always disconnect the negative terminal of the battery.

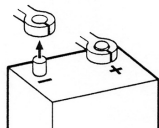

Routing wires

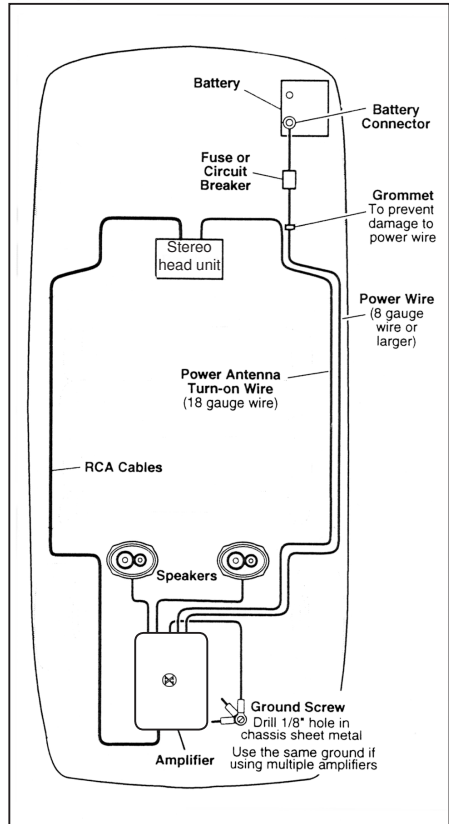

Professional Tip:

If amplifier installation kits are available with different size of power cable, chose the most heavy power cable to improve sound quality and to allow more amplifiers to be installed now or later. The amplifier power terminals accept AWG 4 cables, so If possible buy AWG 4 = 21 mm² cable for best performance. Both the positive wire and the ground wire must have the same size. To avoid cable fire, be sure not to oversize the main fuse value for the power wires.

THE DC-FEED

Maximum main fuse values for different cable sizes.

6 mm ² (9 AWG)	:25 A	10 mm ² (7AWG)	:40 A
16 mm ² (5AWG)	:60 A	21 mm ² (4AWG)	:100 A
33 mm ² (2AWG)	:150 A	42 mm ² (1AWG)	:200 A



Power wiring

Tools and material needed

Tools:

- Flat and Phillips screwdrivers
- Wire cutter
- Wire stripper
- Electric drill with drills
- Crimping tool
- Digital multimeter or test lamp
- Wire brush, scraper or a piece of an abrasive sheet to remove paint for a good ground connection
- Grease to protect the ground connection from oxidation

Material:

- Speaker wire: minimum 12 AWG = 4 mm² for subwoofers
13 – 16 AWG = 1,5-2,5 mm² for other speakers
- Sheet metal screws for mounting the amplifier to the amplifier board and the amplifier board to the car + some extra for fuse holder, amplifier ground etc.
- Electrical insulation tape
- ½ inch thick plywood or particle board for the amplifier to be mounted upon.

Amplifier installation kit:

If available, buy an amplifier installation kit. It contains normally all you need. This is what you have to buy if you buy the items separately

- 20- 25 feet = 6- 7,5 meter power cable, minimum AWG 8 = 10 mm² or heavier
- 1 pc of fuseholder to install close to the car battery + fuse 40 -50 Ampere.
- 20 feet of AWG 15 = 1,5 mm² wire for remote turn on / off cable from radio.
- RCA-cable for input from radio.
- - 20 feet or 5 meter for trunk installations.
- -12 feet or 2 – 3 meter for under seat installations
- Two ring crimp terminals (RT22) –one for connection to the battery plus and one for the amplifier ground connection.
- Four to eight splicers to connect speaker cables to high level input cable, if high level input is used.
- Wire ties
- Insulating grommet or insulating tube

Fuses

Use only 25 ampere ATC blade type fuses when replacing a blown fuse. P44 uses 2 x 40 A fuses, the others 25A.

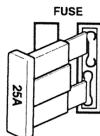

Power terminal (+12V)

Connect the fuse holder as close to the vehicle battery + as possible, using AWG 4 /5 = 21 / 16 mm² power cable. Use a ring crimp terminal to connect to battery. The AWG4 cable can use an 80 Amp fuse, if the cable is smaller, the fuse value must be lower (see table on previous page).

BATT+ REMOTE GND

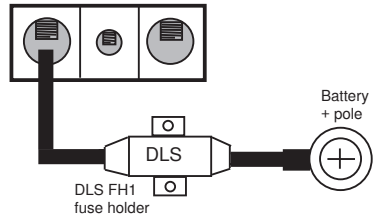

Be sure to use a rubber grommet or a plastic insulating tube where the cable passes the firewall or other places where it can be easily jammed. Use wire ties to secure to existing cables in the engine compartment.

Ground Terminal (GND)

Connect to a good chassis ground. The ground connection should be clean, unpainted metal to provide a good electrical connection. Use a wire brush, a scraper or a piece of an abrasive sheet to clean the metal. Use a lock washer or two to secure contact. Protect with silicon grease or by paint applied afterwards.

BATT+ REMOTE GND

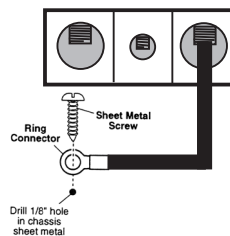

A cable up to AWG 4 (21 sq mm) fits the amplifier ground (GND) terminal

Power Light / Protect light

- Power (green)
Protect (Red)
 - Power (green)
Protect (Red)
- The power light (green) comes on when the amplifier is turned on.
- The protect light (red) comes on when the amplifier shuts down from over-heating, or a short circuit (speaker failure).
- Turn off your audio system to reset the amplifier if the red protect light is turned on. If the red lamp doesn't turn off, contact your local dealer for advice.
- P20 has only one LED



Remote terminal (REM)

For RCA cable signal input:

Connect the radio power antenna lead = remote turn on/off from the car stereo to the amplifier remote connection. This turns on the amplifier whenever the car stereo is turned on. You can either use the built in remote cable in the RCA cable itself or use a separate cable.

Sometimes a small disturbance may enter the amplifier coming from the remote voltage , through the built in remote wire and into the RCA cable. Thus we recommend to use a separate remote wire and run the RCA lead separate from remote wire, power cables and speaker cables.

If there is no remote voltage available from the stereo, you must connect to the ignition key through the radio or any accessories fuse.

When high level input is used the amplifier starts automatically when signal appears on the input.

BATT+ REMOTE GND



To head unit Power Antenna lead or remote output.

A cable up to AWG 7 (10 sq mm) fits the amplifier remote (REM) terminal.

Low level Input Wiring

Inputs may be low level from the RCA output of the car stereo or high level from the car stereo speaker output.

Low level = RCA is to prefer for the best sound quality.

Important

Use either the low level or high level input, do not use both at same time.

Low level input

Use a pair of shielded stereo audio cables with RCA type jack. Most trunk-mount amplifiers need a 20 feet RCA cable (appr 5 – 6 meters).

Connect to input socket L / R (P10) , CH1 / CH2 (P20).

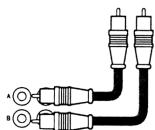

P40 / M40 / P44 have dual inputs CH1 / CH2 / CH3 / CH4 Depending on your chosen configuration you can use either two separate RCA cables, or a single RCA cable together with an Y-split to connect both inputs.

High Level Input wiring

For High Level input:

Most headunits are pre-installed from the car factory and have no RCA output, in this case you can take the signal from the speaker output instead.

Use either a separate remote cable or let the high level signal automatically start the amplifier.

Connect left and right speaker wires coming from the car stereo to the high level input as shown. You must connect both plus and minus as the inputs are balanced, connecting plus only gives lower level and bad sound quality. By changing the polarity of plus and minus, you can change the phase. Connect the black wire to minus ground.

P10, P20

On these two models you connect as in this example:

HIGH INPUT

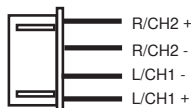

Hi level input plug.

P40/M40/P44

The four channel amplifier is connected likewise, however we have four channels.

You can feed two channels from RCA and two channels using high level input from rear speaker cables,

HIGH INPUT

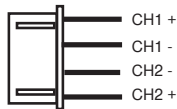
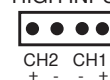

Hi level input plug.

HIGH INPUT

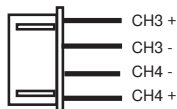
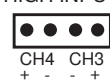

Hi level input plug.



Input Level control - GAIN

The GAIN control, MIN – MAX, matches the output of your radio to the input of the amplifier. After installation is complete, make sure the input of the amplifier is turned down all the way to MIN. After turning on the head unit you can adjust the GAIN level, A normal setting is from 12 - 14 o' clock.

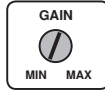

High Pass filter (HPF) - P20,P40,M40,P44

The high pass filter blocks very low frequencies from reaching the speakers. It is mostly used to protect small speakers (like 5 inch and smaller) from deep bass.

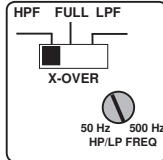

Set the switch in position **HPF** to activate the filter. Test which setting sounds best. The filter can be set at **FULL** position if you want to run the amplifier in full range mode without limiting the frequency range.

Low Pass filter (LPF) - P20,P40,M40,P44

The low pass filter is mostly used for subwoofers. It will allow low frequencies only and blocks higher frequencies. A typical setting is 60 – 70 Hz.

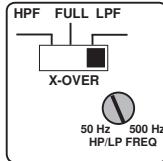

Set the switch in **LPF** position to activate the filter. Set the switch in **FULL** position if you want to run the amplifier in full range mode.

Low Pass filter (LPF) - P10

The low pass filter is mostly used for subwoofers. It will allow low frequencies only and blocks higher frequencies. A typical setting is 60 – 70 Hz.

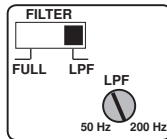

Set the switch in **LPF** position to activate the filter. Set the switch in **FULL** position if you want to run the amplifier in full range mode.

BASS EQ / BASS BOOST

Bass EQ or Bass boost is used to increase the bass volume at a low frequency. You can select the amplification in two steps 0 dB (no amplification) or 6 dB.

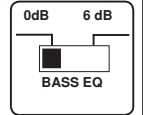

P20 has Bass EQ in three steps, 0, +6 dB, or +12 dB. The 6dB position is often the best choice to avoid distorted sound.

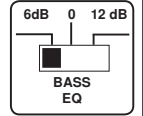

This function is used to compensate for the bass box function and to adjust for your own taste of bass.

Features on each model

The **P10** is a 1-channel mono amplifier. Can be used for one or more subwoofers

The amplifier has the following filters / features:

- Lowpass filter adjustable from 50 to 200 Hz, the filter can be switched off.
- Remote level control.
- Bass Boost in two steps, 0 or +6 dB @ 60 Hz

The **P20** is a 2-channel amplifier. Can be used for a pair of stereo speakers or a subwoofer connected in mono bridge mode.

The amplifier has the following filters / features:

- Lowpass filter adjustable from 50 to 500 Hz, the filter can be switched off.
- Highpass filter adjustable from 50 to 500 Hz, the filter can be switched off.
- Bass EQ in three steps, 0, 6 dB or 12 dB

The **P40/M40/P44** are 4-channel amplifiers for use in various connections:
- a front speaker pair and a subwoofer
- two stereo speaker pairs
- two subwoofers in mono bridge mode
- one stereo speaker pair in bridge mode

The amplifier has the following filters / features:

- Lowpass filter adjustable from 50 to 500 Hz, the filter can be switched off.
- Highpass filter adjustable from 50 to 500 Hz, the filter can be switched off.
- Bass EQ in two steps, 0 or 6 dB on CH3 / CH4



Speaker wiring P10

Two 4 ohm subwoofers

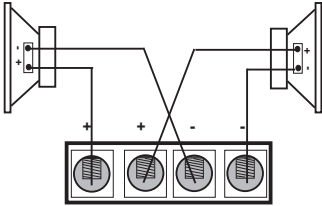

NOTE!

Two 4 ohm subwoofers gives a 2 ohm load when connected in this way. Minimum amplifier load is 2 ohm, lower impedances may damage the amplifier.

One 4 ohm or 2 ohm subwoofer

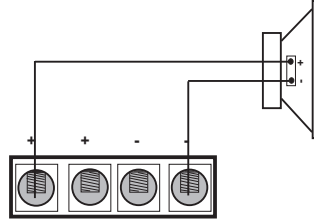

NOTE!

Subwoofer impedance can be 4 ohm or 2 ohm. Minimum amplifier load is 2 ohm, lower impedances may damage the amplifier.

CONNECTIONS IN SERIES OR PARALLEL
Subwoofers with dual voice coils, or any subwoofer, can be connected in series or in parallel for various impedances but **the resulting impedance must never be lower than 2 ohm.**

Filter settings Low Pass filter

The low pass filter is mostly used for subwoofers. It will allow low frequencies only and blocks higher frequencies.

A typical setting is 60 – 70 Hz.

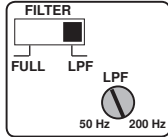

Set the switch in **LPF** position to activate the filter. Set the switch in **FULL** position if you want to run the amplifier in full range mode.

Remote sub level control

You can adjust the bass sound level from the front seat of your car if you connect the external sub level control box.

Connect to **REM** socket.

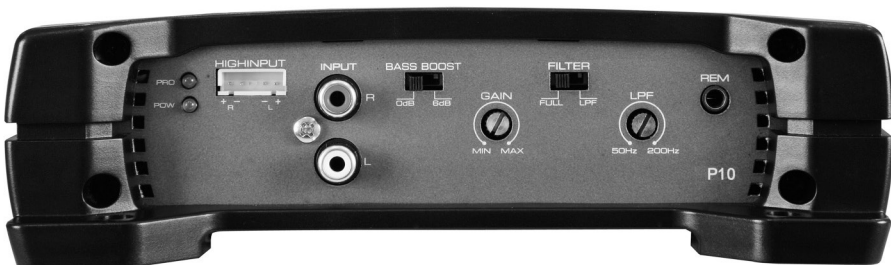
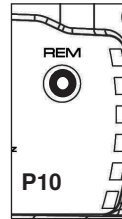

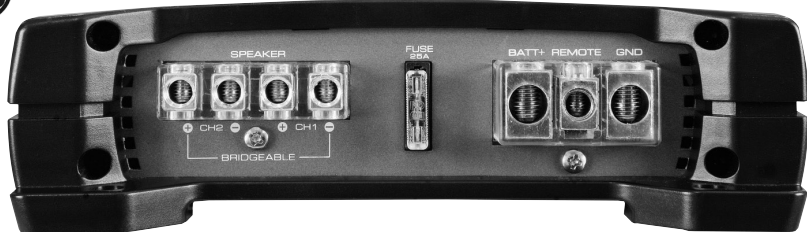

Speaker wiring P20

Two fullrange speakers to channel 1 / 2

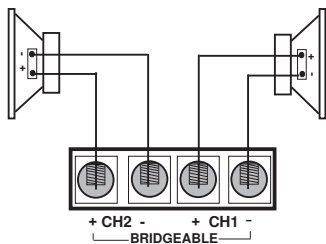

NOTE!

Minimum amplifier load is 2 ohm in stereo mode, lower impedances may damage the amplifier.

One 4 ohm subwoofer bridged

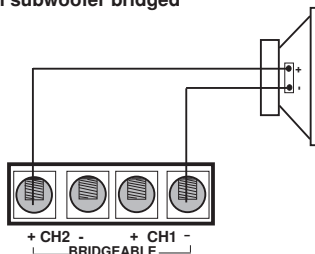

NOTE!

Minimum speaker impedance in bridged connection is 4 ohm, this connection gives a 2 ohm load with a 4 ohm subwoofer (the load is halved when connected in bridge mode).

Do **NOT** use subwoofers with lower impedance than 4 ohm. Connect speaker + to CH2+ and speaker - to CH1 -.

Filter settings CH 1/2 for 2-channel stereo use

The high pass filter (**HPF**) blocks very low frequencies from reaching the speakers. It is mostly used to protect small speakers (like 5 inch and smaller) from deep bass.

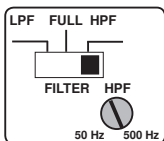

Set the switch in position **HPF** to activate the filter. Adjust with the **HPF control** after your own taste, a normal setting is 50 - 70 Hz.

The filter can be set at **FULL** position if you want to run the amplifier in full range mode without limiting the frequency range.

Filter settings CH 1/2 for subwoofer use

The low pass filter (**LPF**) is mostly used for subwoofers. It will allow low frequencies only and blocks higher frequencies. A typical setting is 60 - 70 Hz.

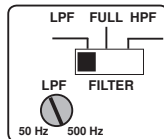

Set the switch to **LPF** position to activate the filter. Use this position when connected to a subwoofer.

Set the switch to **FULL** position if you want to run the amplifier in full range mode.

For power wiring, see page 3-4

For high or low level input wiring, see page 4



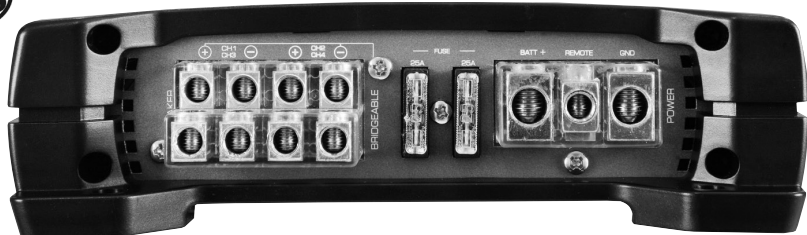

Speaker wiring P40 / M40 / P44

1. Four fullrange speakers. One pair in front and one pair in rear.

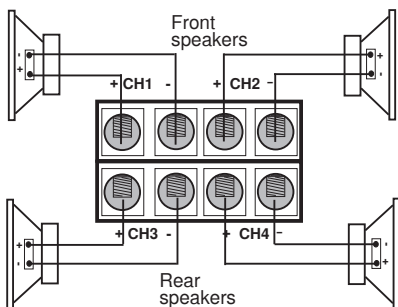

Front and rear stereo speakers connected to front & rear channels

Filter settings front channels CH 1 / 2

The high pass filter (HPF) blocks very low frequencies from reaching the speakers. It is mostly used to protect small speakers (like 5 inch and smaller) from deep bass.

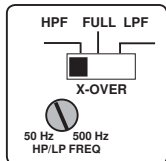

Set the switch in position **HPF** to activate the filter. Adjust with the **HPF control** after your own taste, a normal setting is 50 - 70 Hz.

The filter can be set at **FULL** position if you want to run the amplifier in full range mode without limiting the frequency range.

Filter settings rear channels CH 3 / 4

For the rear channels 3/4 the filter should be adjusted in the same way as for channels 1/2.

The **BASS EQ** switch on CH3 / CH4 should be in position 0 dB

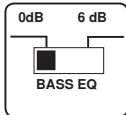

For power wiring, see page 3-4
For high or low level input wiring, see page 4

2. Two fullrange speakers and one subwoofer bridged. (3-channel mode).

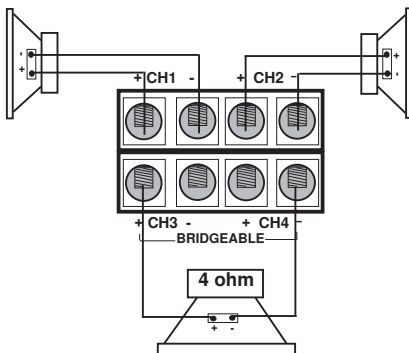

Rear or front stereo speakers connected to channels 1 / 2 and subwoofer to channels 3 / 4.

Filter settings front channels CH 1 / 2

The high pass filter (HPF) blocks very low frequencies from reaching the speakers. It is mostly used to protect small speakers (like 5 inch and smaller) from deep bass.

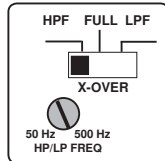

Set the switch in position **HPF** to activate the filter. Adjust with the **HPF control** after your own taste, a normal setting is 50 - 70 Hz.

The filter can be set at **FULL** position if you want to run the amplifier in full range mode without limiting the frequency range.

Filter settings rear channels CH 3 / 4

The low pass filter (LPF) is mostly used for subwoofers. It will allow low frequencies only and blocks higher frequencies.

A typical setting is 60 - 70 Hz.

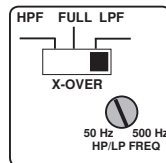

Set the switch to **LPF** position to activate the filter. Use this position when connected to a subwoofer.

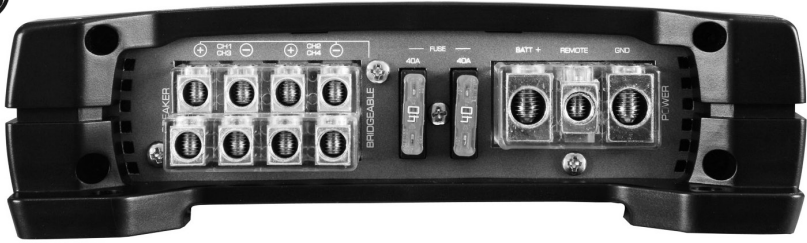

Speaker wiring P40 / M40 / P44

3. Two subwoofers bridged.

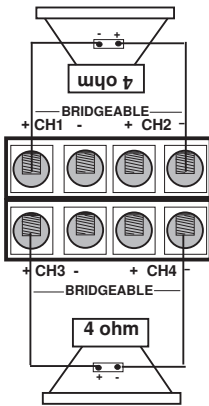

One 4 ohm subwoofer connected to channels 1 / 2 and one 4 ohm subwoofer to channels 3 / 4.

Filter settings front channels CH 1 / 2

Filter settings rear channels CH 3 / 4

The low pass filter (LPF) is mostly used for subwoofers. It will allow low frequencies only and blocks higher frequencies. A typical setting is 60 – 70 Hz.

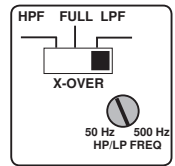

Set the switch to **LPF** position to activate the filter. Use this position when connected to a subwoofer.

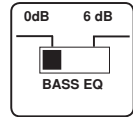
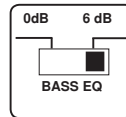

For power wiring, see page 3-4

For high or low level input wiring, see page 4





Troubleshooting Testing

If problems occur during the installation, or later, this guide might help you to find out what's wrong.

THE AMPLIFIER IS DEAD:

1. Check power lead, ground and remote connections at the amplifier using a multi meter.
2. Check the battery terminal connections.
3. Check the power lead fuse or circuit breaker. If fuse damage continues, inspect the power lead for short circuits.
4. Check the amplifier protection fuses. Are these broken change to new ones with the same value. If short circuiting continues, contact your local DLS dealer. A fault may exist in the amplifier.
5. To start the amplifier requires a remote voltage of 9-15 volt. Check the voltage with a multi meter.

AMPLIFIER PROTECTION FUSE BLOWS AT LOW VOLUME :

1. One or more speaker cables are shorted. Make an insulation test with a multi meter. The cables must not have a connection to earth.

THE AMPLIFIER TURNS OFF AFTER 10 - 30 MINUTES.

The amplifier is overheating due to inadequate ventilation. Check mounting position is free from obstruction.

Do this:

1. Move the amplifier to a place with better ventilation.
2. Install one or two fans to cool down the heat-sink.
3. Overheating can also be caused by an impedance load below the level permitted.

NO OUTPUT FROM ONE OR MORE SPEAKERS:

Check the following:

1. Balance control position.
2. Fader control position.
3. Speaker cable connections to both amplifier and drivers.
4. Signal lead plugs and cables.
5. Change left and right signal lead plugs in the amplifier to see if the problem moves to a different speaker, the lead has a fault. If the problem remains, the speaker or amplifier are at fault.

Before you finish the installation, you should do the following tests to make sure the wiring is correct and everything is operating properly.

Reconnect Battery

When wiring is complete, reconnect the battery negative terminal.

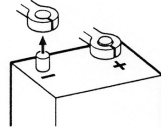

Test power wiring

1. Turn on the head unit but do not turn up the volume. The amplifier power light should come on. If not, check the remote and +12 volt wires. Also check the ground connection.
2. Turn up the head units volume slightly. All speakers should operate. If not, check wiring connections at amplifier and speakers.

Test speaker connections

Make sure the speakers are connected right. Use the balance control on the head unit to make sure right channel is on right speaker etc. If speakers don't play at all, one or both speaker wires may be disconnected.



Professional Tip:

NOISE PROBLEMS

WHINING NOISE VARYING WITH ENGINE REVOLUTIONS:

Do this:

1. Rewire the power supply (12 V) to source unit direct from battery.
2. Rewire ground wire from source unit to clean position on chassis.
3. Check all power connections to ensure that they are clean and tight.
4. Check quality of system ground connection.
5. Install a Power Cap capacitor. This can be helpful against most noise problems.

CONSTANT WHINING NOISE:

Do this:

1. Ensure that all equipment has a common ground point.
2. Check quality of earth strap connection from battery negative terminal to chassis.
3. Disconnect signal cables from amplifier to see if noise disappears. If so the leads are picking up noise. Test this by laying a new cable over the seats and reconnecting to the amplifier. If the noise does not return, re-route original cable away from source of interference.

If noise remains regardless of cable position, try to use so called Quasi-balanced signal cables. DLS PRO-cables are Quasibalanced.

Professional Tip:

Installing in trunk

When installing the amplifier in the trunk, run the power wires along the same path as the other vehicle wiring. Many cars have insulated channels for wiring, you will have to remove the door sill trim and the carpet.

Professional Tip:

Crimp connections

Purchase crimp connectors and crimping tool. Connectors are color coded.

1. Strip 1/4 inch (6 mm) of insulation from the wire.
2. Insert into connector
3. Crimp tightly

Professional Tip:

SPEAKER POLARITY CHECK.

All speakers in a car audio system should be connected in phase (the same polarity). All speaker cones must move in the same direction. Out of phase speakers will cause a lack of bass, and a poor stereo soundstage.

Checking polarity:

Hold the - connection of the speaker wire to the - terminal of a 1,5 Volt flashlight battery. Tap the + wire on to the + terminal of the battery, and observe the movement of the cone. The cone should move outwards when the wire touches the battery, and inwards when the battery is removed. If it is the other way around, the speaker has been connected backwards and it must be removed and connected correctly.

If your system also has a subwoofer connected through a passive 6 or 12 dB crossover, try to connect this with various polarity and judge what sounds best. The phase shift in passive crossovers sometimes makes it necessary to change polarity.

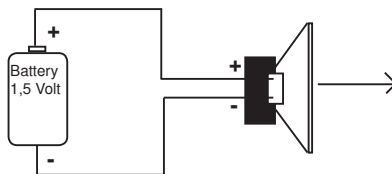

NOTE! Tweeters can not be tested this way, double check the connections instead.

Professional Tip:

Securing wires

Use wire ties to bundle together when possible. (But never bundle speaker wires or signal cables together with power wires.)

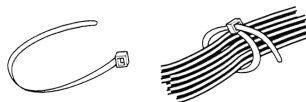

Professional Tip:

Speaker and power wires

Do not run speaker and power wires next to each other. Power wires can generate a "siren" sound in the speakers. Run speaker and power wires on opposite sides of the car.



Specifications

P10

Number of channels	1
Amplifier class	AB
Power output RMS, 2 ohm (1% THD)	450 W
Peak music power, 2 ohm	800 W
Power output RMS, 4 ohm (1% THD)	260 W
Signal to noise ratio, A-weighted	>95 dB
Damping factor	>80
Frequency response	10 Hz - 30 kHz
Input impedance, low level	22 kohm
Input sensitivity	0,25 - 5V
Input impedance, high level	47 ohm
High level input with auto start	Yes
Filter low pass variable	50-200 Hz*
* can be switched in/out	
Bass boost @ 50 Hz	+6 dB
Cooling fan in bottom plate	Yes
Remote sub level control	Yes
Power consumption, idle	0,6 A
Power consumption, max	50A
Fuse	2 x 25 A
Dimensions HxWxD(mm)	55 x 188 x 320
Dimensions (inch)	2,16 x 7,4 x 12,6
Weight	3 kg

All output power ratings are RMS Watts @ 14,4 VDC.
The 1% figures are CEA2006 standard

P20

P40/M40*

P44

	P20	P40/M40*	P44
Number of channels	2	4	4
Amplifier class	AB	AB	AB
Power output, 4 ohm (0,1% THD)	2 x 70 W	4 x 70 W	4 x 100 W
Power output, 2 ohm (0,2% THD)	2 x 100 W	4 x 100 W	4 x 140 W
Peak music power, 2 ohm	2 x 150 W	4 x 150 W	4 x 250 W
Power output, 4 ohm bridged (1% THD)	1 x 200 W	2 x 200 W	2 x 280 W
Signal to noise ratio, A-weighted	>95 dB	>95 dB	>95 dB
Damping factor	>80	>80	>80
Frequency response	10 Hz - 30 kHz	10 Hz - 30 kHz	10 Hz - 30 kHz
Input impedance, low level	22 kohm	22 kohm	22 kohm
Input sensitivity	0,25 - 5V	0,25 - 5V	0,25 - 5V
Input impedance, high level	47 ohm	47 ohm	47 ohm
High level input	Yes	Yes	Yes
Filter high-pass variable	50 - 500 Hz*	50 - 500 Hz*	50 - 500 Hz*
Filter low pass variable	50-500 Hz*	50-500 Hz *	50 - 500 Hz*
* can be switched in/out			
Bass EQ @ 50 Hz	+6 dB / +12 dB	+ 6dB	+ 6dB
Cooling fan in bottom plate	No	Yes	Yes
Power consumption, idle	0,4 A	0,5 A	0,7 A
Power consumption, max	25A	50A	80 A
Fuse	1 x 25 A	2 x 25 A	2 x 40 A
Dimensions HxWxD(mm)	55 x 188 x 210	55 x 188 x 320	55 xx 188 x 400
Dimensions (inch)	2,16 x 7,4 x 8,26	2,16 x 7,44 x 12,67	2,16 x 7,44 x 15,7
Weight	2 kg	3 kg	4 kg

* Marine White aluminium
moisture protected PCB board with stainless casing

We follow a policy of continuous advancement in development. For this reason all or part of specifications & designs may be changed without prior notice.